



## DELTA SOLAR LED LIGHTING



**SONARAY®**



## SR-4080

Power Consumption: 80W  
 Beam Angle: 145°(H)×65°(V)  
 Lighting Duration: 23hrs\*1  
 Time to fully charged: 8hrs\*2  
 Luminaire Material: Aluminum  
 Luminaire Weight: 4kg/8.82lb  
 Solar Panel & Battery Weight: 17.2kg/37.91lb  
 Battery Position: Built-in on the panel  
 Operating Temperature : -25°C~+45°C, -13°F~+113°F  
 Warranty: 5 years

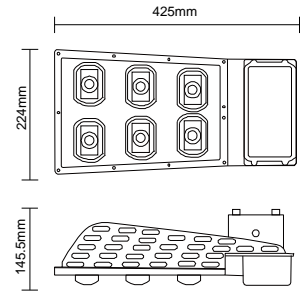

## IP65 IK09

Color Temperature



### Accessories

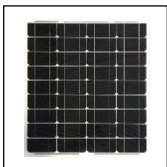

Solar Panel (front)



Solar Panel (back),  
Battery built-in

## Battery Specification

Nominal Capacity	14.8V 30Ahx2
Battery cell	Lithium battery
Battery Life	3yrs
Cycle Life	1000 times
Maximum Charge/ Discharge Current	8A
Standard Discharge Current	5A
Nominal Voltage	14.8V
Max Charge Voltage	16.8V
Discharge Cut-off Voltage	12.0V
Overcharge Detection Voltage	4.25V±0.025V
Overdischarge Detection Voltage	2.5V±0.1V
Overdischarge Detection Current	7A~15A

## Solar Panel Specification

### Specifications

Maximum Power (Pmax)	150Wp
Maximum Power Voltage (Vmp)	18V
Maximum Power Current (Imp)	8.34A
Open-Circuit Voltage (Voc)	22V
Short-Circuit Current (Isc)	9.18A
System Voltage	1000V
Tolerance	±3%

### Mechanical Characteristics

Solar Cell	Mono(156x156)
Number of Cells	36(4x9)
Dimension	1480x670x97mm
Frame	Aluminum alloy

Note: \*1The duration refers to the time for which the luminaire could work continually with the battery fully charged.

\*2 The time refers to the duration in which the battery could be fully charged under the effective illumination of the solar panel.

### Light Distribution Curve

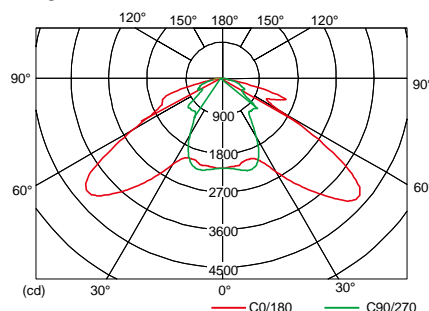

### Illuminance Distribution

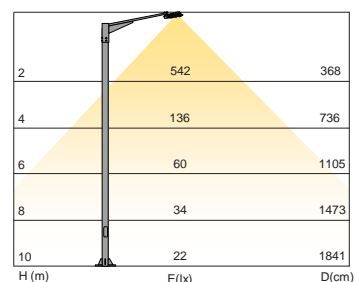

[www.sonarayled.com](http://www.sonarayled.com)

© 2015 DASCOM (HOLDINGS), LTD. All rights reserved.  
 All company and product names are trademarks or registered trademarks of their respective owner. Specifications are subject to change without notice.

Version 1.8. Edited date 2015.10





## SR-4040

Power Consumption: 48W  
 Beam Angle: 145°(H)×65°(V)  
 Lighting Duration: 23hrs\*1  
 Time to fully charged: 9hrs\*2  
 Luminaire Material: Aluminum  
 Luminaire Weight: 2.5kg/5.51lb  
 Solar Panel & Battery Weight: 11kg/24.25lb  
 Battery Position: Built-in on the panel  
 Operating Temperature : -25°C~+45°C, -13°F~+113°F  
 Warranty: 5 years

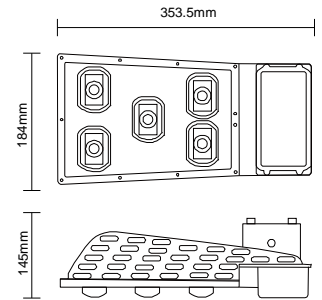

## IP65 IK09

Color Temperature



### Accessories

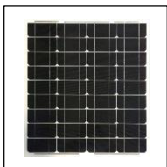

Solar Panel (front)



Solar Panel (back),  
Battery built-in

## Battery Specification

Nominal Capacity	14.8V 30Ah
Battery cell	Lithium battery
Battery Life	3yrs
Cycle Life	1000 times
Maximum Charge/ Discharge Current	8000mA
Standard Discharge Current	2700mA
Nominal Voltage	14.8V
Max Charge Voltage	16.8V
Discharge Cut-off Voltage	12.0V
Overcharge Detection Voltage	4.25V±0.025V
Overdischarge Detection Voltage	2.5V±0.1V
Overdischarge Detection Current	7A~15A

## Solar Panel Specification

### Specifications

Maximum Power (Pmax)	80Wp
Maximum Power Voltage (Vmp)	18V
Maximum Power Current (Imp)	5.02A
Open-Circuit Voltage (Voc)	22V
Short-Circuit Current (Isc)	5.53A
System Voltage	1000V
Tolerance	±3%

### Mechanical Characteristics

Solar Cell	Mono(156x156)
Number of Cells	36(125x125)
Dimension	1196x544x30mm
Frame	Aluminum alloy

Note: \*1The duration refers to the time for which the luminaire could work continually with the battery fully charged.

\*2 The time refers to the duration in which the battery could be fully charged under the effective illumination of the solar panel.

### Light Distribution Curve

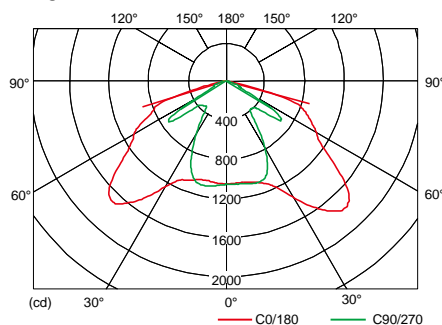

### Illuminance Distribution

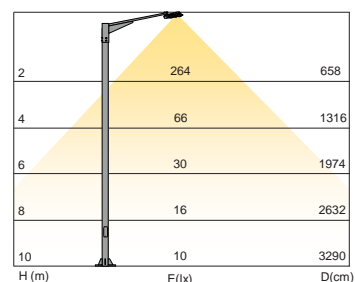

[www.sonarayled.com](http://www.sonarayled.com)

© 2015 DASCOM (HOLDINGS), LTD. All rights reserved.  
 All company and product names are trademarks or registered trademarks of their respective owner. Specifications are subject to change without notice.

Version 1.8. Edited date 2015.10





## SR-4030A / SR-4030B

Power Consumption: 30W  
 CRI: Ra≥80  
 Luminous Flux: 3180lm(6000K)  
 Luminous Efficacy: 106lm/W(6000K)  
 Beam Angle: 120°  
 Lighting Duration: 30hrs\*1  
 Time to fully charged: 8hrs\*2  
 Luminaire Material: Aluminum  
 Luminaire Weight: 2.8kg/6.17lb  
 Solar Panel Weight: 7.35kg/16.20lb  
 Battery Position: Built-in on the luminaire  
 Battery: 14.8V 15Ah, Internal  
 Operating Temperature : -25°C~+45°C, -13°F~+113°F  
 Warranty: 5 years

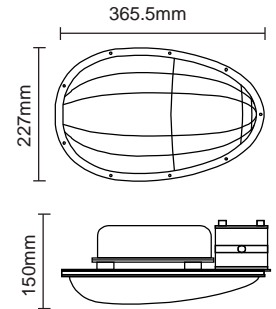

### IP65

#### Color Temperature

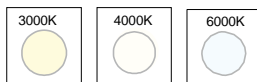

#### Accessories



Solar Panel

#### Illuminance Distribution

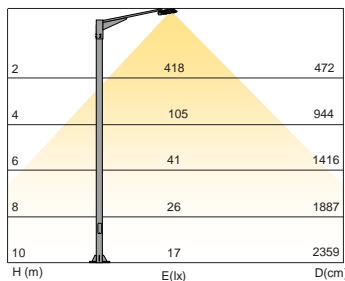

#### Light Distribution Curve

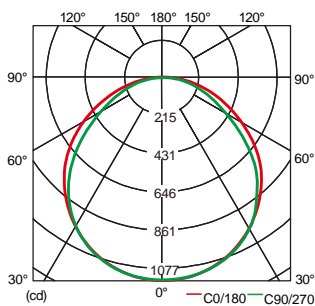

### Battery Specification

Nominal Capacity	15000mAh
Battery cell	Lithium battery
Battery Life	3yrs
Cycle Life	1000 times
Maximum Charge/ Discharge Current	5000mA
Standard Discharge Current	2000mA
Nominal Voltage	14.8V
Max Charge Voltage	16.8V
Discharge Cut-off Voltage	12.0V
Overcharge Detection Voltage	4.25V±0.025V
Overdischarge Detection Voltage	2.5V±0.1V
Overdischarge Detection Current	7A~15A
Relative humidity	10%~90%

### Solar Panel Specification

#### Specifications

Maximum Power (Pmax)	60Wp / 90Wp
Maximum Power Voltage (Vmp)	18V
Maximum Power Current (Imp)	3.33A
Open-Circuit Voltage (Voc)	21.4V
Short-Circuit Current (Isc)	3.78A
System Voltage	1000V
Tolerance	3±

#### Mechanical Characteristics

Solar Cell	Mono125x78mm
Number of Cells	36 (4x9)
Dimension	765x550x35mm / 1196x550x30mm
Frame	Aluminum alloy
Surface Glass	3.2mm, High Transmittance, Low Iron, Tempered Glass

Note: \*1The duration refers to the time for which the luminaire could work continually with the battery fully charged.  
 \*2 The time refers to the duration in which the battery could be fully charged under the effective illumination of the solar panel.

[www.sonarayled.com](http://www.sonarayled.com)

© 2015 DASCOM (HOLDINGS), LTD. All rights reserved.  
 All company and product names are trademarks or registered trademarks of their respective owner. Specifications are subject to change without notice.

Version 1.8. Edited date 2015.10





SR-4030A / SR-4030B

**Motion Sensor**

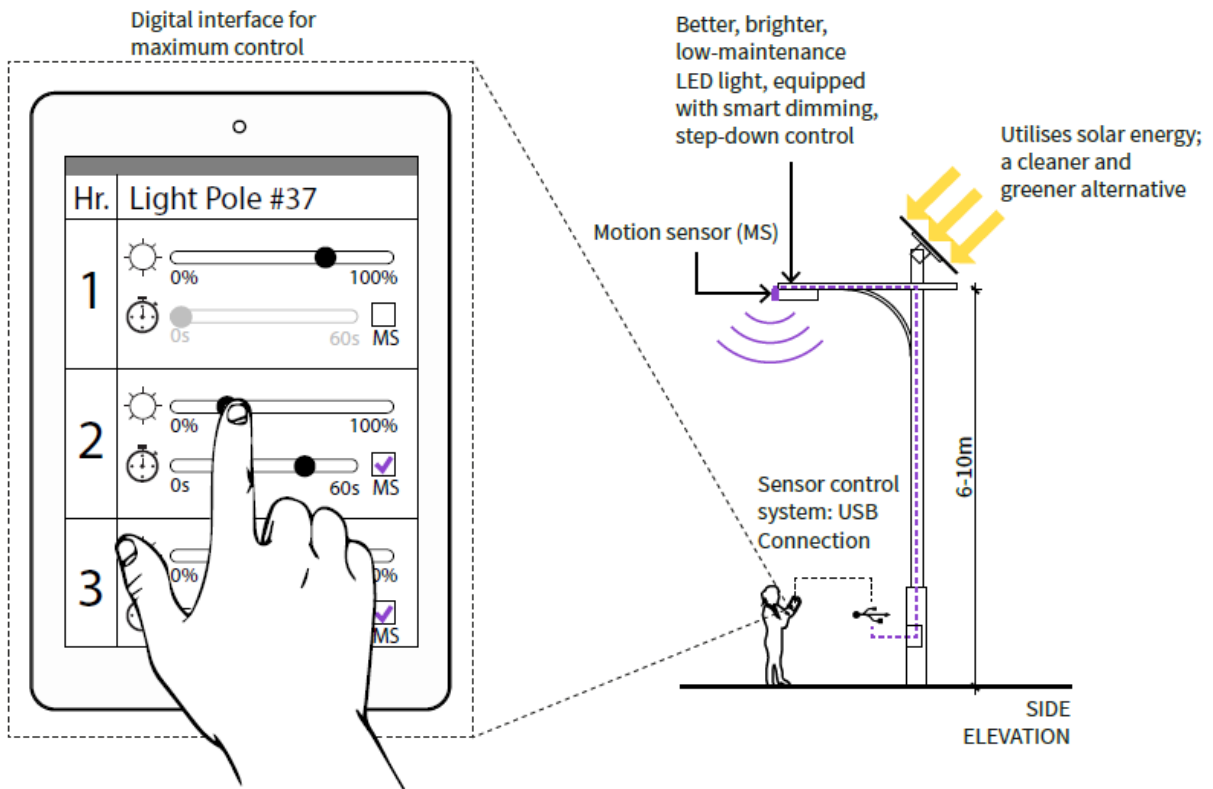

[www.sonarayled.com](http://www.sonarayled.com)

© 2015 DASCOM (HOLDINGS), LTD. All rights reserved.  
 All company and product names are trademarks or registered trademarks of their respective owner. Specifications are subject to change without notice.

Version 1.8. Edited date 2015.10





## SR-1020

Power Consumption: 20W  
 CRI: Ra≥80  
 Luminous Flux: 2000lm(6000K)  
 Luminous Efficacy: 100lm/W(6000K)  
 Beam Angle: 120°  
 Lighting Duration: 23hrs\*1  
 Time to fully charged: 6hrs\*2  
 Luminaire Material: Aluminum  
 Luminaire Weight: 2.58kg/5.69lb  
 Solar Panel Weight: 3.5kg/7.716lb  
 Battery Position: Built-in on the luminaire  
 Battery: 14.8V 10Ah, Internal  
 Operating Temperature : -25°C~+45°C, -13°F~+113°F  
 Warranty: 5 years

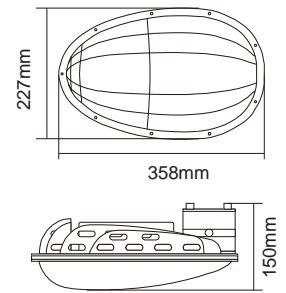

## IP65

### Color Temperature

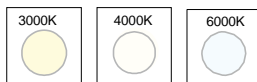

### Accessories

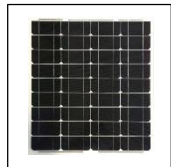

Solar Panel

### Light Distribution Curve

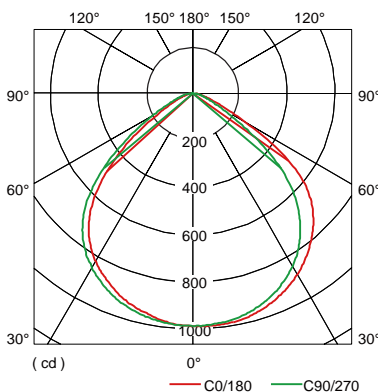

### Illuminance Distribution

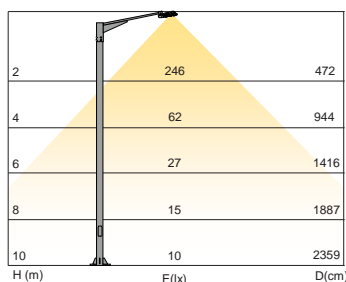

## Battery Specification

Nominal Capacity	10000mAh
Battery cell	Lithium battery
Battery Life	3yrs
Cycle Life	1000 times
Maximum Charge/ Discharge Current	5000mA
Standard Discharge Current	1400mA
Nominal Voltage	14.8V
Max Charge Voltage	16.8V
Discharge Cut-off Voltage	12.0V
Overcharge Detection Voltage	4.25V±0.025V
Overdischarge Detection Voltage	2.5V±0.1V
Overdischarge Detection Current	7A~15A
Relative humidity	10%~90%

## Solar Panel Specification

### Specifications

Maximum Power (Pmax)	40Wp
Maximum Power Voltage (Vmp)	18V
Maximum Power Current (Imp)	2.23A
Open-Circuit Voltage (Voc)	22V
Short-Circuit Current (Isc)	2.46A
System Voltage	1000V
Tolerance	±3%

### Mechanical Characteristics

Solar Cell	125x62.5
Number of Cells	4x9
Dimension	641x544x25mm
Frame	Aluminum alloy
Surface Glass	3.2mm, Super White Tempered Glass

Note: \*1The duration refers to the time for which the luminaire could work continually with the battery fully charged.

\*2 The time refers to the duration in which the battery could be fully charged under the effective illumination of the solar panel.

[www.sonarayed.com](http://www.sonarayed.com)

© 2015 DASCOM (HOLDINGS), LTD. All rights reserved.

All company and product names are trademarks or registered trademarks of their respective owner. Specifications are subject to change without notice.

Version 1.8. Edited date 2015.10





## SR-1010

Power: 10W  
 Luminous Flux: 630lm(6000K)  
 Luminous Efficacy: 63lm/W(6000K)  
 Beam Angle: 120°  
 Lighting Duration: 17hrs\*1  
 Time to fully charged: 7~8hrs\*2  
 Battery: 7.4V 15Ah  
 Solar Panel: 20W  
 Luminaire Material: Aluminum  
 Weight: 4.7kg/10.36lb  
 Operating Temperature: -42°C~+50°C, -44°F~+122°F  
 Warranty: 5 years

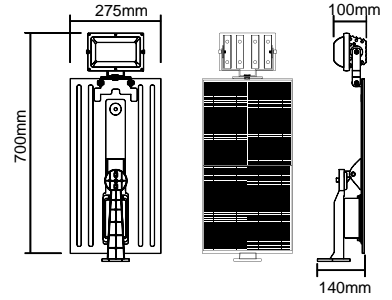

## IP65

Color Temperature

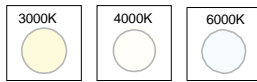

## Battery Specification

Nominal Capacity	15000mAh
Cycle Life	1000 times
Maximum Charge/ Discharge Current	7500mA
Standard Discharge Current	1350mA
Nominal Voltage	7.4V
Max Charge Voltage	8.4V
Discharge Cut-off Voltage	6.0V
Overcharge Detection Voltage	4.25V±0.05V
Overdischarge Detection Voltage	3.0V±0.05V
Relative humidity	10%~90%

Note: \*1The duration refers to the time for which the luminaire could work continually with the battery fully charged.

\*2 The time refers to the duration in which the battery could be fully charged under the effective illumination of the solar panel.

Light Distribution Curve

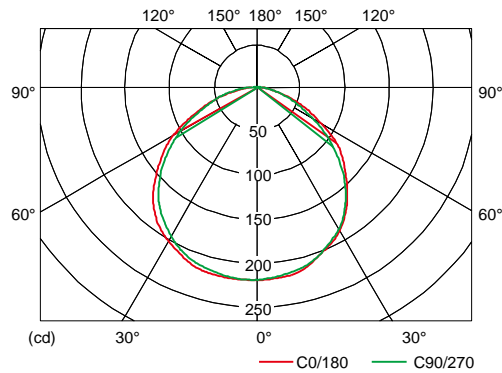

Illuminance Distribution

1	213	284
2	53	567
3	24	851
4	13	1134
5	9	1418
H (m)	E (lx)	D (cm)



## SR-1004

Power: 4W  
 Luminous Flux: 224lm(6000K)  
 Luminous Efficacy: 56lm/W(6000K)  
 Beam Angle: 120°  
 Lighting Duration: 15hrs\*1  
 Time to fully charged: 7hrs\*2  
 Battery: 7.4V 5Ah  
 Solar Panel: 10W  
 Luminaire Material: Aluminum  
 Weight: 1.65kg/3.64lb  
 Operating Temperature: -42°C~+50°C, -44°F~+122°F  
 Warranty: 5 years

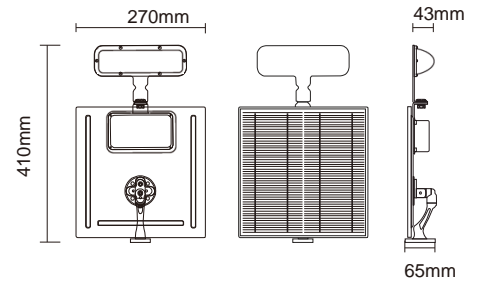

## IP65

Color Temperature

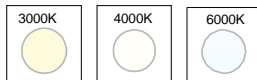

## Battery Specification

Nominal Capacity	5000mAh
Cycle Life	1000 times
Maximum Charge/ Discharge Current	2500mA
Standard Discharge Current	540mA
Nominal Voltage	7.4V
Max Charge Voltage	8.4V
Discharge Cut-off Voltage	6.0V
Overcharge Detection Voltage	4.25V±0.05V
Overdischarge Detection Voltage	3.0V±0.05V
Relative humidity	10%~90%

Note: \*1The duration refers to the time for which the luminaire could work continually with the battery fully charged.  
 \*2 The time refers to the duration in which the battery could be fully charged under the effective illumination of the solar panel.

Light Distribution Curve

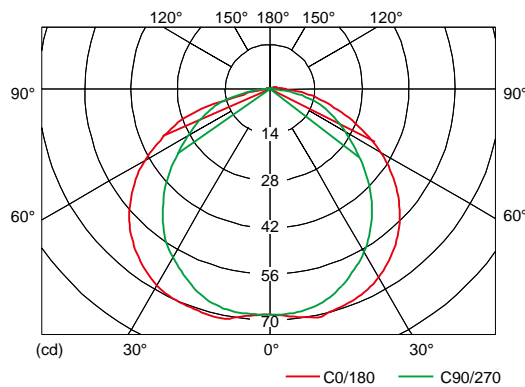

Illuminance Distribution

1	65	274
2	16	547
3	7	821
4	4	1195
5	3	1369
H (m)	E (lx)	D (cm)